

A-A (4:1)

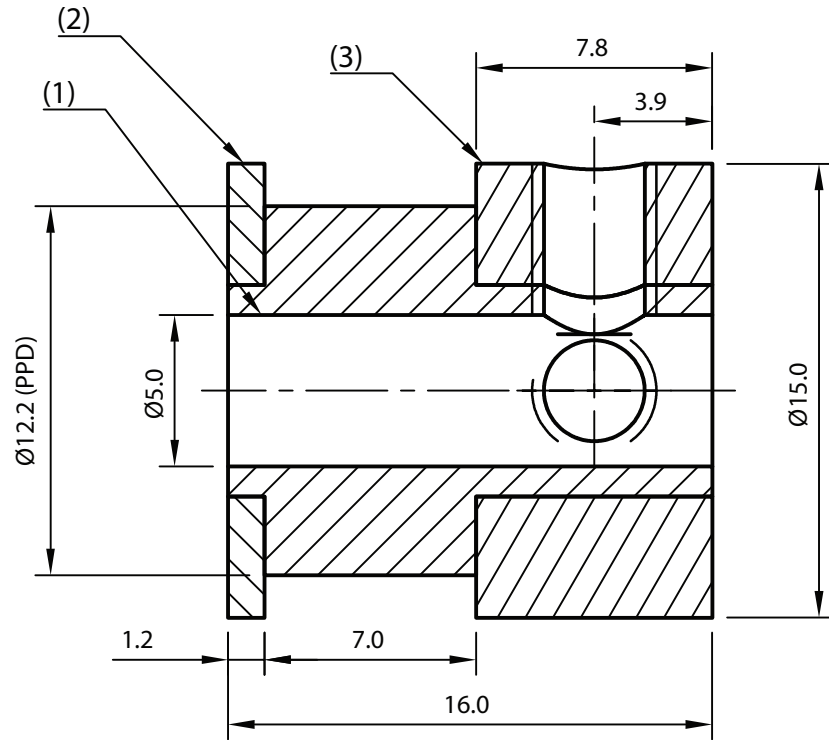

REVISION HISTORY			
REV	DESCRIPTION	DATE	APPROVED
1	FIRST	06/11/18	RY

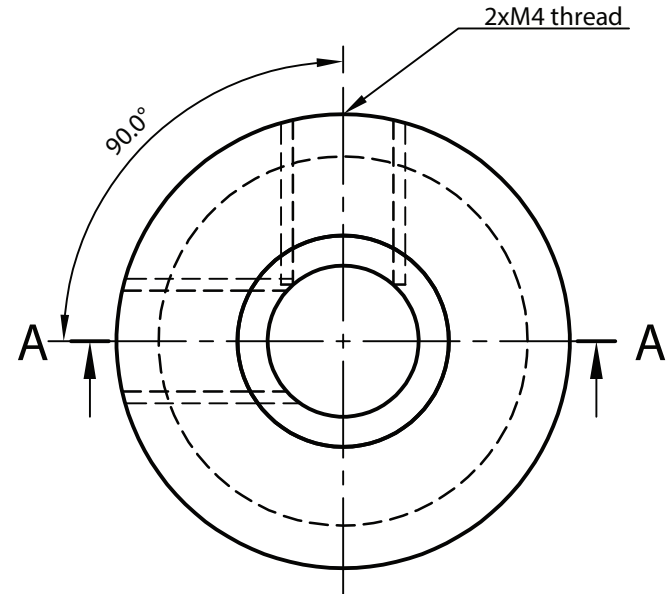

1	3	BLOCK	A6061
1	2	FLANGE	A6061
1	1	PULLEY	A6061
Qty.	Part No.	Part Name	Material

Copyright (C) E3D-Online Ltd (e3d-online.com)
 These drawings are free hardware you can redistribute it and / or modify it under the terms of the General Public License as published by the Free Software Foundation, either version 3 of the License, or (at your option) any later version.

THIRD ANGLE PROJECTION
 ALL DIMENSIONS IN MM
 MATERIAL: ALUMINIUM
 SCALE: 4:1
 SURFACE FINISH: UNFINISHED

TOLERANCES UNLESS OTHERWISE STATED:
 X ±0.2
 X.X ±0.1
 X.XX ±0.05

Dept. Engineering	Technical reference	Created by JS	Approved by RY		
		06/11/18	06/11/18		
		Document type PRODUCTION	Document status RELEASED		
		Title Gates Pulley 20 Tooth 6mm	DWG No. M-PULLEY-GT2-20T-6-P5-C-H160		
		Rev. 1	Date of issue	Sheet 1/1	